

**MAGMA Permanent Mold**

# Autonomous Engineering



## Permanent Mold

- Robust solutions for gravity and low pressure permanent mold casting
- Systematic process and tool design
- Process knowledge through virtual experimentation
- Quantification of mechanical properties in the as-cast state and for T6 heat treatment
- Estimation of costs and CO<sub>2</sub> emissions

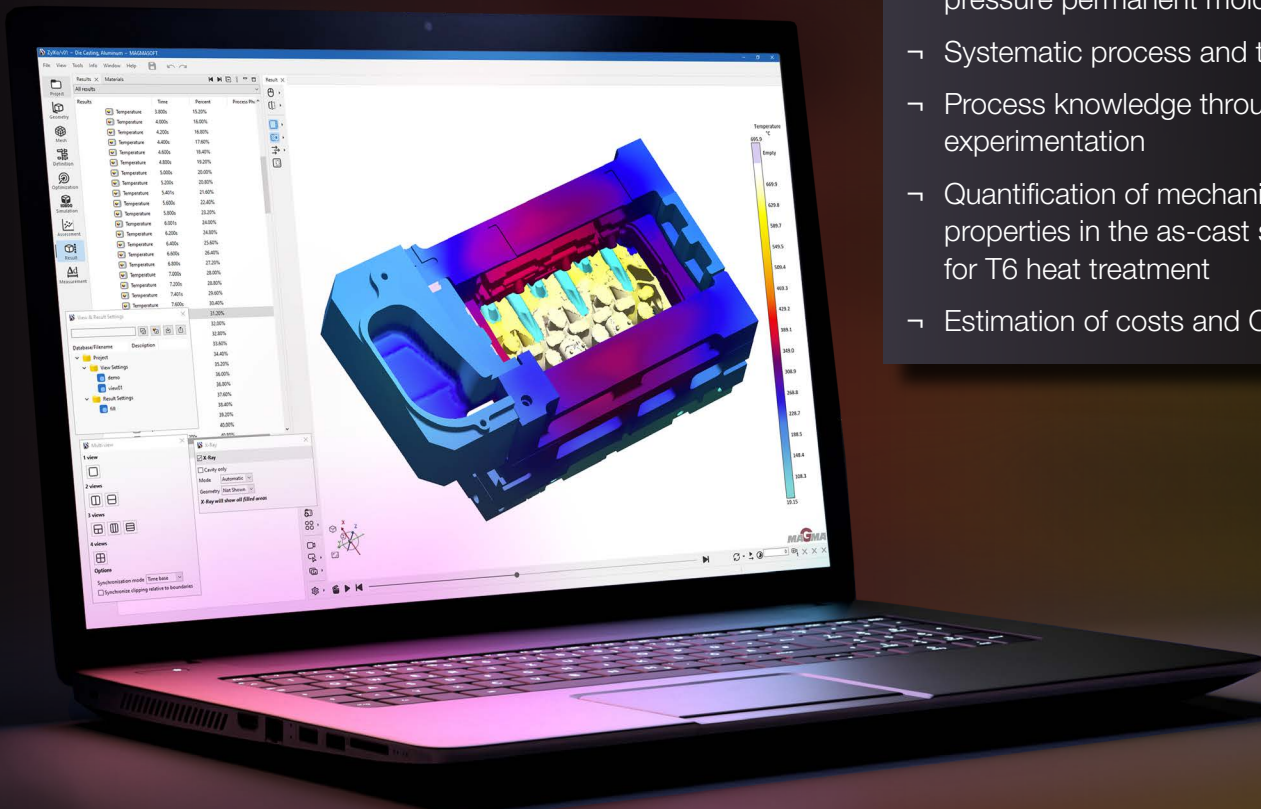

# Robust, Economical, Fast, **Optimized**

**Optimize all aspects of production in your foundry and find the best solution for your requirements – with MAGMASOFT® autonomous engineering.**

MAGMASOFT® is the comprehensive and powerful simulation software for the layout and design of the process and tooling in permanent mold casting. Starting with the improvement of the casting quality, through the optimization of the tooling, to the adjustment of robust process conditions, ensuring optimal profitability. The focus is on your resources, time and costs.

With MAGMASOFT®, you use simulations in an automated virtual design of experiments or genetic optimization. The result is Autonomous Engineering: systematic and fully automated decision-making for casting layouts and production conditions.

With Autonomous Engineering, you can simultaneously pursue different quality and cost goals. This applies to the assurance of casting quality and process robustness, from the concept stage to the final design of the casting layout and the continuous improvement of profitability in production.

MAGMASOFT® autonomous engineering:

- Supports you in the comprehensive prediction of all process steps for the common permanent mold casting processes.
- Offers you a virtual test environment to systematically avoid casting defects.
- Enables you to make quick decisions and saves time for all parties involved.
- Allows proactive quality management by understanding process fluctuations.
- Improves communication and cooperation within your organization and with customers.

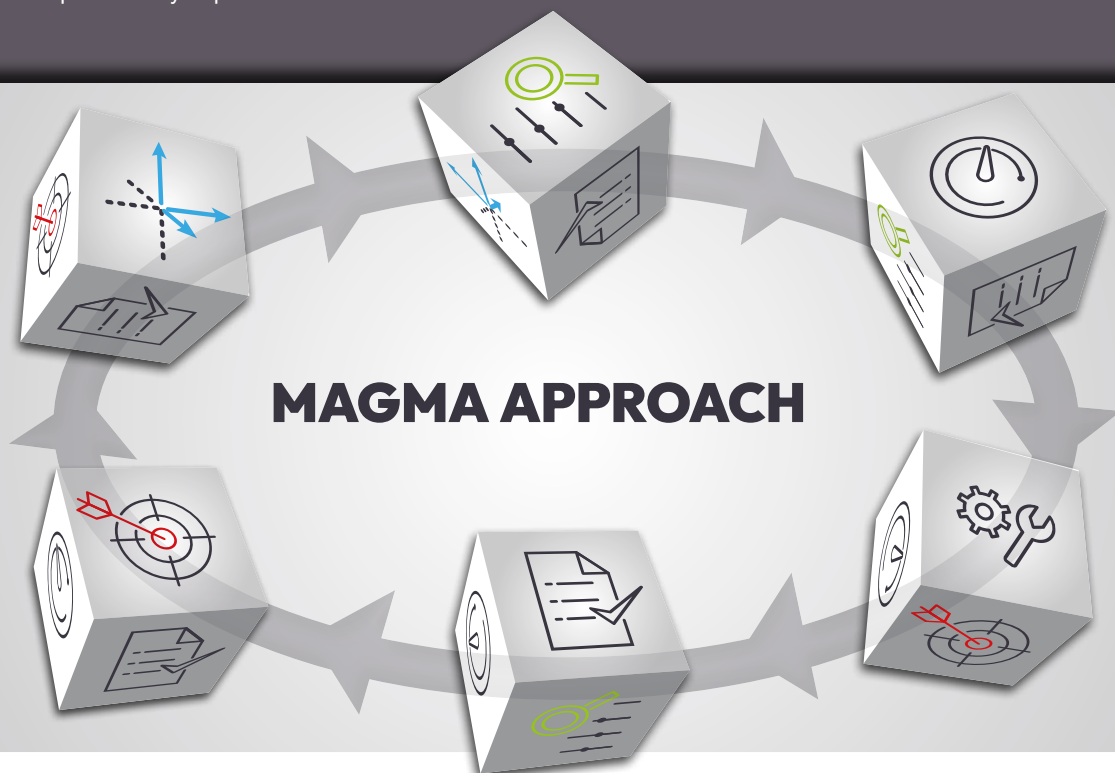

## Targeted and Systematic Success

The MAGMA APPROACH, which is fully integrated in MAGMASOFT®, is a systematic methodology for achieving your objectives using virtual experiments. In combination with MAGMASOFT® autonomous engineering, secured actions can be identified and implemented to achieve continuous improvements, without economic risks.

The MAGMA APPROACH supports you at every stage of the product development or improvement process, through a systematic methodology. The result is a robust casting process that is optimally designed for the desired objectives and that enables stable production conditions taking into account alloy chemistry, melting practice and metallurgy.

# Set Your Objectives, Define Your Variables, Specify Your Criteria

The quality and profitability of permanent mold castings is determined by the design, the process conditions and the casting layout. With MAGMASOFT® autonomous engineering, simulations can be carried out and automatically evaluated to pursue different quality and cost objectives. The result is a robust process that is optimally designed to meet your goals and avoid casting defects, residual stresses, component distortion, and die wear.

MAGMASOFT® for permanent mold casting processes enables a comprehensive simulation and optimization of the die casting process with all essential process steps and conditions.

From a simplified solidification analysis of the casting with an 'automatic mold' during the quotation phase, to a detailed process model with mold halves, sliders, sand cores or inserts, as well as complex cooling and heating lines.

## Simple Modeling

Intelligent assistants and convenient CAD functionality support you in target-oriented and effective model preparation enabling short times to answer with minimum effort. Use the extensive database of parametric geometries or the simple segmentation of complex CAD data using the 'cutting knife' capabilities.

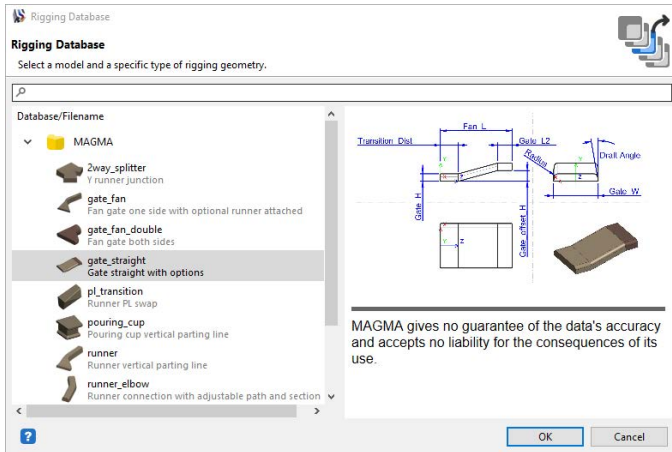

Comprehensive database with fully parametric geometries for all essential elements of the gravity die casting process

## Intuitive Process Control

Easily control all relevant process steps to optimize the casting cycle. From mold preparation through spraying, coating and blowing of selected die sections, to the real sequence of closing of the die halves or individual sliders, to the complete process sequence with delay times up to the start of pouring.

Optimize the cooling and thermal control of the die or the time of casting removal with the help of virtual thermocouples.

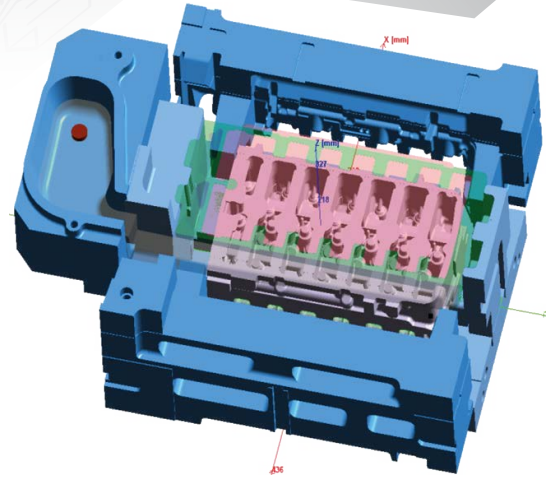

Detailed process model with mold halves, sliders, sand cores or inserts, as well as complex cooling and heating lines

## Mold Filling and Solidification

You can define the mold filling process either as a function of pouring time, pouring rate or, alternatively as automatic filling control of the pouring basin.

For tilt casting applications, optionally use the time dependent rotation angle as an optimization variable.

Mold filling takes into account the surface tension of the alloy, the venting conditions and the entire time-dependent thermal balance in the die. Feeding of shrinkage in the casting during solidification takes place as a function of the local metallostatic pressure.

Multiple options for die tempering in gravity die casting applications:

- Heating of the mold before starting production
- Influence of flow through cooling lines on local heat transfer from the die
- Effects of electrical heating cartridges and Variotherm control on the die thermal balance

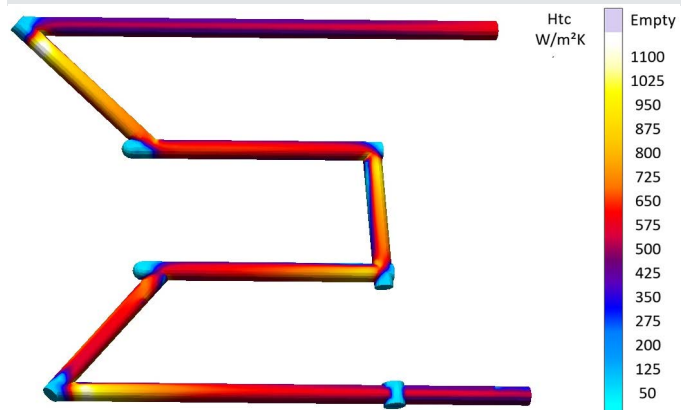

Local heat transfer coefficients calculated based on the flow conditions in cooling and heating lines.



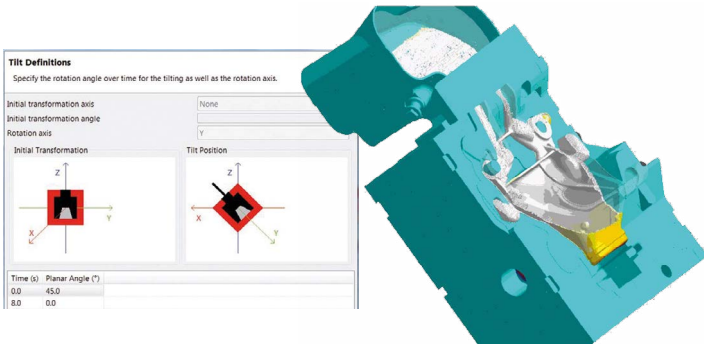

Definition of the rotational movement in the tilt casting process

Evaluate and optimize factors such as:

- How do the process steps spraying, coating and blowing affect the thermal balance in the die or the risk for cold shuts and oxides in the component?
- What happens to air trapped in the gating system?
- Which parameters for pouring time, pouring temperature, and die thermal control provide the lowest risk for porosity?
- How do critical tool areas behave with regard to premature die wear?

Use MAGMASOFT® results to design robust and economical casting layouts considering aspects such as macroporosity, microporosity or die soldering, taking into account the cyclic temperature profile.

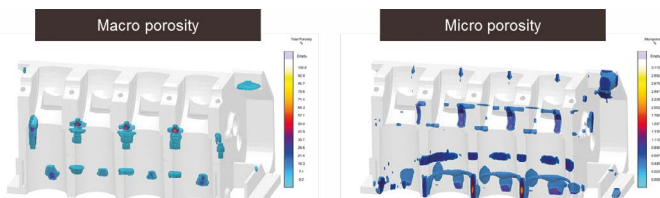

Display of macro- and microporosity

Use the automated variation of the geometry, position and process settings of thermal control elements to meet the specified quality requirements in a reliable manner. Optimize the energy balance of individual cooling elements or the overall system in order to reduce thermal loads on the die.

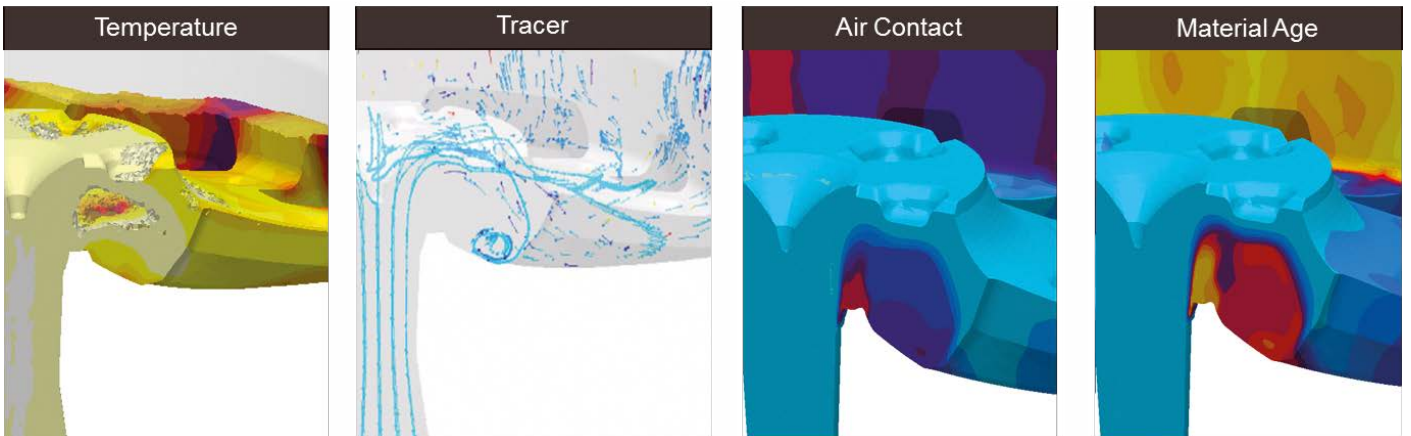

MAGMASOFT® results for mold filling and analysis of potential casting defects such as cold shuts or oxide inclusions

The visualization of the energy exchange between materials and material groups (energy balance) over the entire process, individual process phases or defined time periods enables you to optimize the energy and cost efficiency of your casting production.

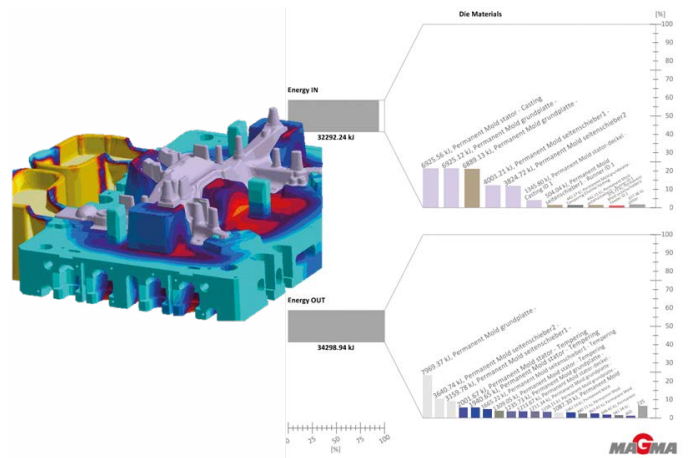

Energy balance across all materials and process phases – optimization of energy and cost efficiency in gravity die casting

When using sand cores, the energy input through the melt leads to degradation of the sand binder along with the formation of core gases.

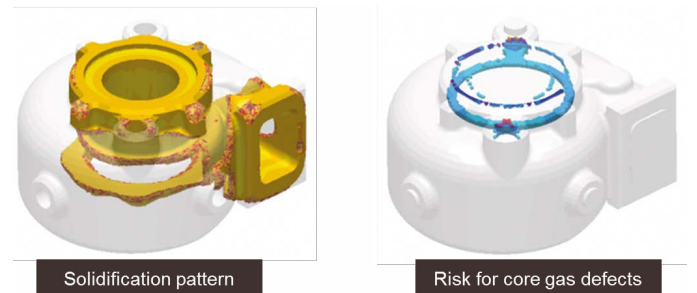

Risk areas for core gas defects depending on local solidification conditions and binder degradation

Visualize the local risk of core gas defects and systematically analyze the impact of optimized venting conditions or adjusted sand parameters using automated virtual experiments.

# Microstructure and Mechanical Properties

MAGMASOFT® enables a comprehensive simulation of microstructure during the solidification of aluminum alloys. Alloy chemistry, metallurgy and the process sequence are taken into account. This allows the quantitative prediction of local microstructures and mechanical properties.

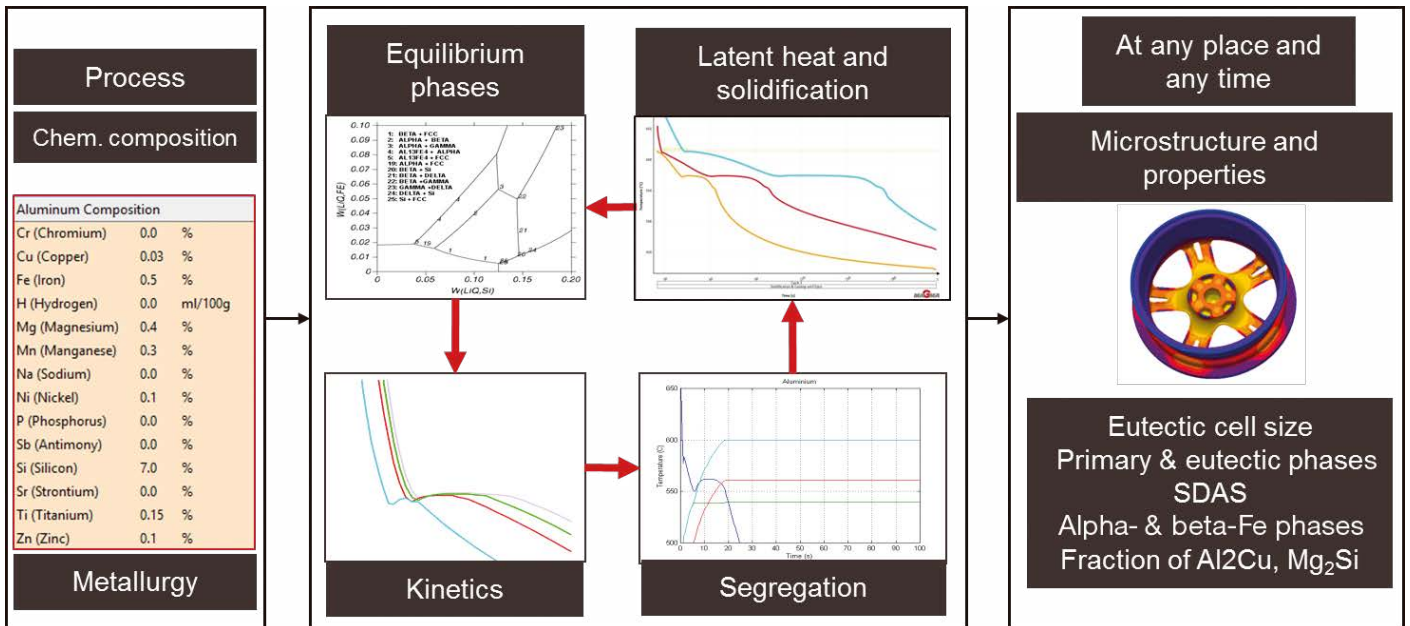

Calculation loop for the prediction of local microstructure and resulting mechanical properties

Optimize the distribution of mechanical properties in your component, for example, with regard to:

- Achieving maximum tensile strength, yield strength or elongation
- Avoiding unwanted or damaging phases
- Minimizing areas critical for microporosity
- Exploiting the potential of the material and the process

The prediction of the alloy and process-specific microstructure provides the following information:

- Fraction of primary and eutectic phases
- Fraction of intermetallic AlFeMnSi, AlFeSi, Al<sub>2</sub>Cu and Mg<sub>2</sub>Si phases
- Local secondary dendrite arm spacing, SDAS
- Grain size distribution of the primary phase
- Eutectic cell sizes
- Porosity distribution
- Local yield strength, tensile strength and elongation in the as-cast state and after T6 heat treatment

Use information for early communication in the product development process and to reduce cost-intensive prototypes.

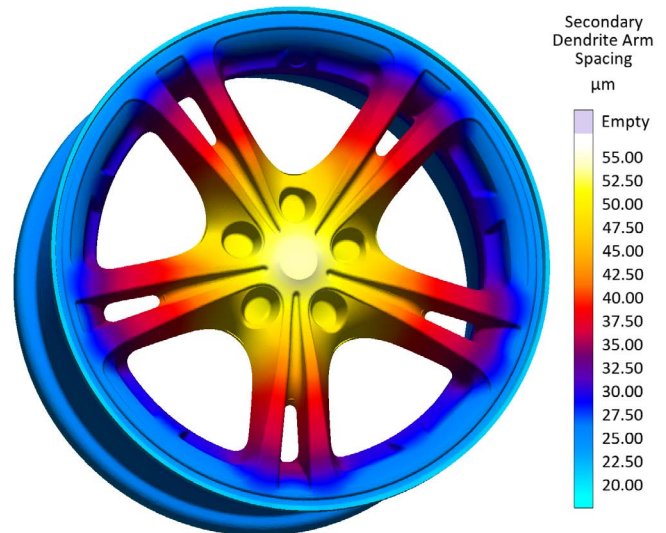

Calculated local secondary dendrite arm spacing

## Residual Stresses and Distortion

MAGMASOFT® enables the comprehensive simulation and optimization of low-pressure sand and gravity die casting as well as wheel casting processes, considering all essential process steps and boundary conditions.

Create the low-pressure specific material groups and functionality for bottom, side and top cores using CAD import or parametric models in MAGMASOFT®.



## Low pressure permanent mold casting

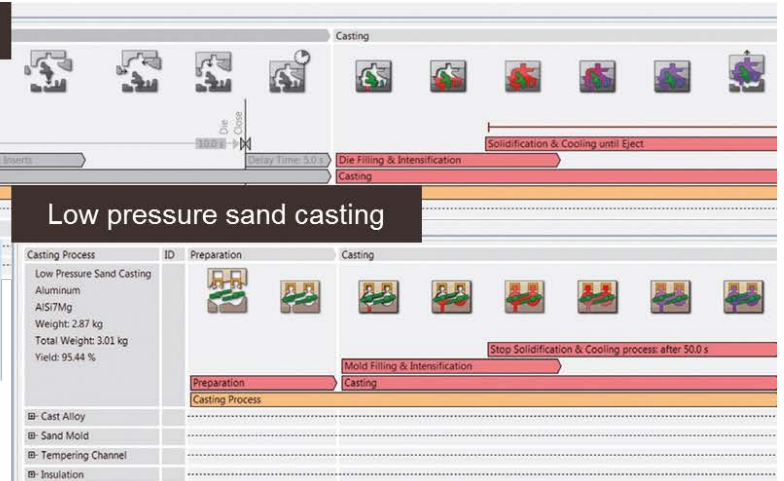
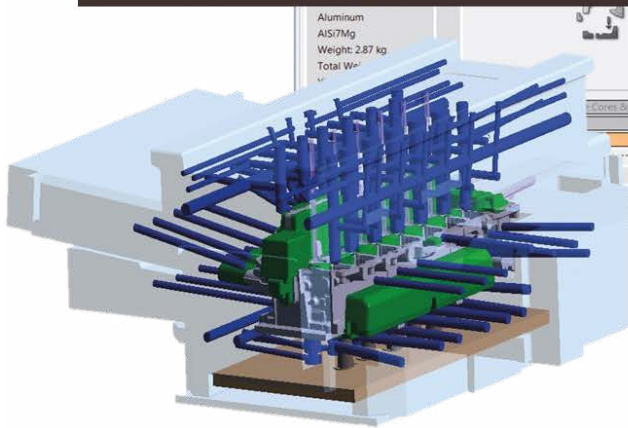

## Low pressure sand casting

Intuitive process-specific flow charts for low pressure die casting and sand casting

The use of sand cores or inserts is also possible, as well as the individual configuration of cooling and thermal control systems.

As a result of the temperature field in the die and the casting solidification pattern, residual stresses occur in the cast component.

Analyze the risk for hot tears and cold cracks resulting from the manufacturing process, the distortion of the casting or the die lifetime of critical tool areas depending on the ejection time or robustness of die cooling elements.

MAGMASOFT® enables the prediction of the local deformation of sand cores.

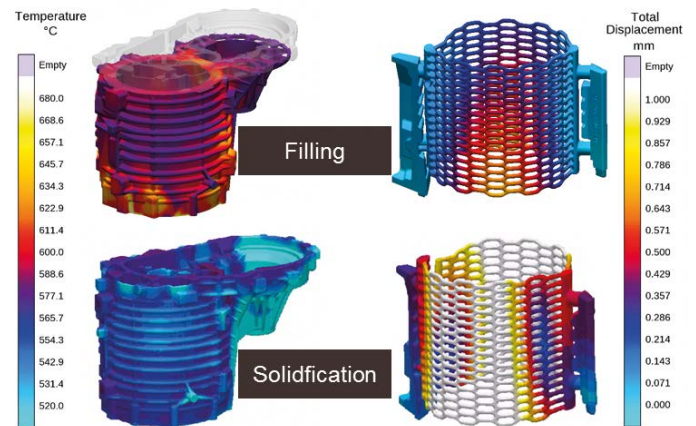

Deformation of sand cores during mold filling and solidification

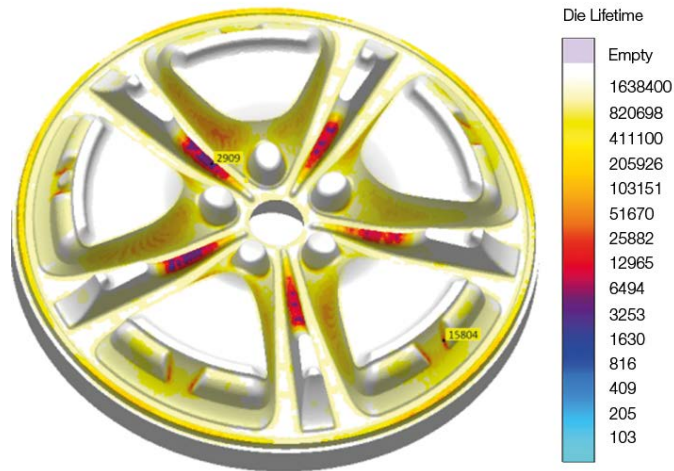

Local die life prediction considering thermo-mechanical stresses

The complex calculation of sand core distortion considers the alignment of core prints, the flow and buoyancy forces during mold filling, the shrinkage forces during solidification as well as the time- and temperature-dependent mechanical properties of the sand core.

## The Robust Process

MAGMASOFT® helps you to lay out, evaluate and efficiently design your heat treatment processes with integrated capabilities for statistically evaluating virtual experiments.

The early virtual analysis of process fluctuations on the quality, functionality and service life of the cast component avoids time-consuming and cost-intensive testing on the machine.

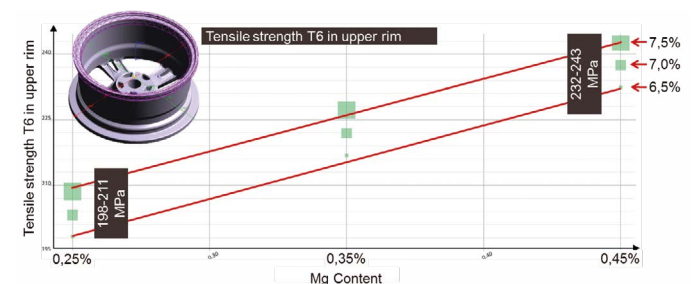

Influence of Mg and Si on the variation of tensile strength after T6

MAGMASOFT® autonomous engineering shows you the process window for ensuring the local microstructure and the resulting mechanical properties. Robustness generates economic efficiency – from your initial design idea to a reliable start of production!

# Work Efficiently and Systematically

Your time is limited! To achieve your goals, it is crucial to systematically and efficiently utilize all the available possibilities in MAGMASOFT®'s comprehensive toolbox.

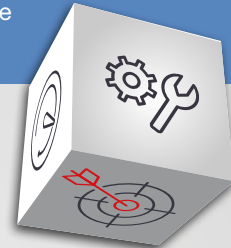

## Intuitive Process Control

Intelligent assistants support you in estimating the pressure conditions for filling the stalk, castings and cavities.

Use the automated variation of the filling conditions as a function of the pressure in the furnace or at the gate for comprehensive optimization of the cast quality or reduction of the cycle time.

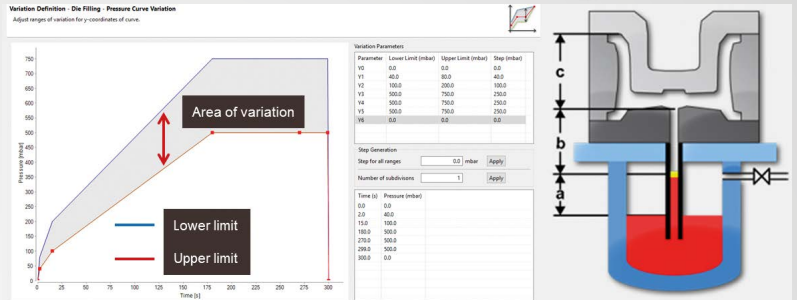

Assistants for fast and easy estimation of pressure conditions for filling the stalk, casting and cavity

# MAGMA ECONOMICS Technology & Profitability

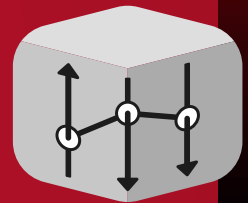

MAGMA ECONOMICS expands technical optimization with MAGMASOFT® to include economic decision-making criteria. This allows identifying savings potentials that are often overlooked in purely technical simulations. The information provided by MAGMASOFT® thus creates additional opportunities as a management tool within the company.

## Optimize Your Casting Quality, Cost & Carbon Footprint

MAGMA ECONOMICS calculates and compares costs, energy consumption and CO<sub>2</sub> emissions of different scenarios. The perspective draws on existing geometry, material and process data as well as simulation results.

Customizable templates for common materials and processes contain specific cost and emission factors, enabling a detailed analysis of resource consumption and production costs along the entire casting process – from tooling preparation to actual casting and possible machining steps.

## Key Features

- **New perspective:** comprehensive quantitative analysis of costs, energy and resource consumption, and CO<sub>2</sub> emissions, coupled with quality criteria in MAGMASOFT®
- Intuitive evaluation of quality, productivity, project costs, and sustainability as key tool for your competitiveness
- **Database:** evaluation based on existing geometries, materials, processes, and simulation results
- **Customizable templates:** templates for materials and processes with specific cost and emission factors
- **Scenario comparison:** individual variation of process parameters and comparison of different scenarios – thanks to intuitive control – without additional simulation time
- **Autonomous Engineering:** seamless integration with optimization and virtual design of experiments

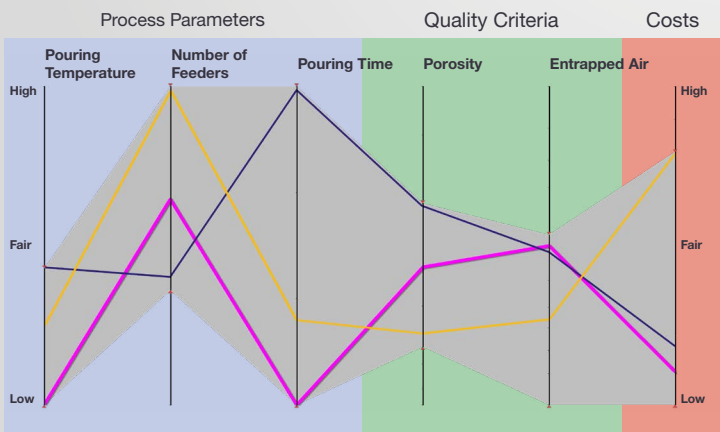

With MAGMA ECONOMICS, the parallel coordinate diagram as established, interactive tool for analyzing process variations and quality criteria is complemented by corporate criteria such as costs, energy/resource consumption and sustainability.

Systematically and quickly find the best compromise between quality and costs (violet line) and the limits of your robust manufacturing process (process window, marked in gray).

# Act & Check Your Improvements

Success is more than software and hardware. MAGMA's professional team is ready to comprehensively support you in realizing your goals. You can take advantage of the services of our MAGMAacademy, engineering and support teams when and how it suits you, and all from a single source.

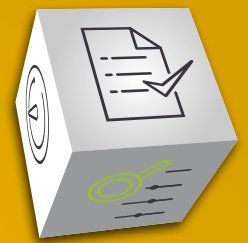

## Implementation

All MAGMASOFT® programs are more than just software. They offer a methodology for optimizing engineering, communication and profitability in your organization.

Even before starting with our software, we will take the time to discuss with you the most important factors to ensure an effective and secured use of our tools based on your situation: from the required computer hardware, through the qualification and training of users, to jointly defining objectives regarding where you want to be in the next year.

Whether you are a new customer or a long-time user of our software: We have plans with you!

## MAGMASupport

MAGMASupport stands for the competent, methodical and fast support of our customers worldwide regarding all questions in the application of and problem-solving with our products. With the MAGMA APPROACH, our qualified support staff will help you to make better use of our software every day.

## MAGMAacademy

The MAGMAacademy systematically supports you in the implementation of both casting process and virtual optimization, from the initial rollout to the comprehensive application of Autonomous Engineering throughout the entire organization.

In our training courses, workshops and seminars, we convey interdisciplinary understanding across all processes and departments for the best possible use of MAGMASOFT® – conducted at our offices or through a customized solution on-site.

## MAGMAengineering

As an independent and competent partner, MAGMAengineering supports a successful virtual product development, tooling design and optimization of your robust foundry processes within the framework of engineering projects.

An interdisciplinary and international team of experts, with numerous years of casting expertise, is available to work with you using MAGMASOFT® autonomous engineering to address your challenges.



More Information:

